

HEAT CONDUCTIVITY

1. Rate of conduction of heat is different in different metals
2. Heat gets transferred from hotter end to colder end

Assembly : Consists of 3 metal rods, copper, brass and stainless steel. These three rods are of 3 mm. in diameter. Brass and stainless steel rods are of 100 mm. in length and copper rod is 125 mm. in length. These three rods are arranged in a metal assembly such that they can be heated simultaneously. The whole arrangement is mounted on a 4 mm. iron bar with wooden handle. The apparatus comes with wax and spirit lamp.

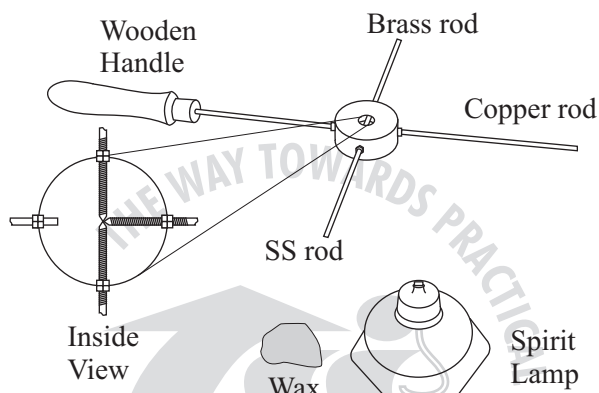

To do and Observe :

Step 1 :

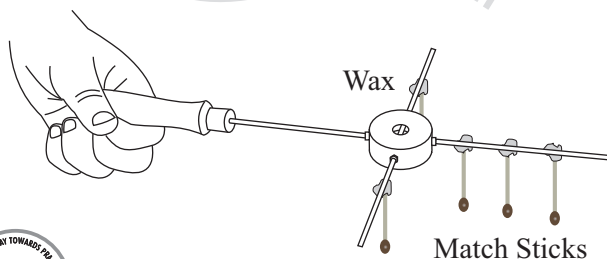

Fix match sticks to the three rods at equal distance from heating point with some wax. Also fix two more match sticks to the copper rod at equal distances as shown in the diagram.

Step 2 :

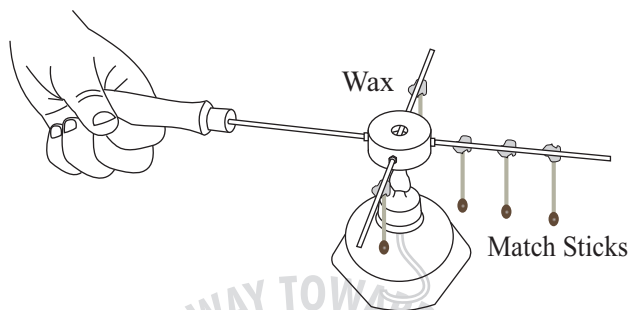

Start heating at the centre where all the three rods meet.

Step 3 :

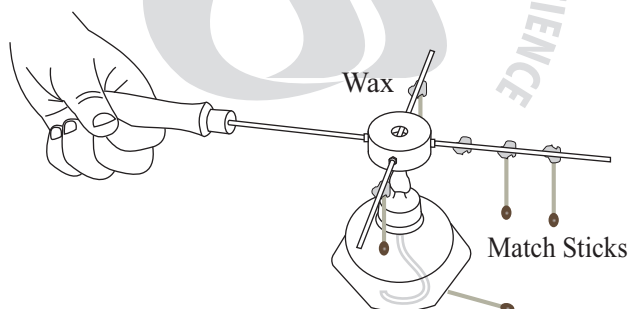

You will notice that the match stick fixed to the copper rod drops first.



Step 4 :

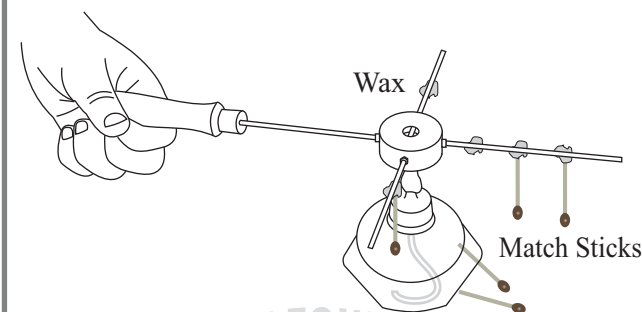

Continue heating. You will notice that the match stick fixed to the brass rod drops the next.

Step 5 :

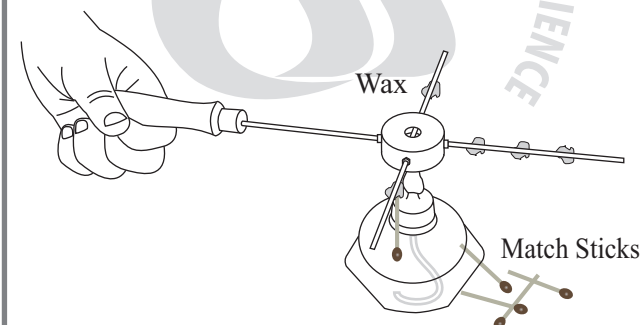

Continue heating. You will notice that the second match stick fixed to the Copper rod drops next and after some interval of time third match stick falls.



Step 6 :

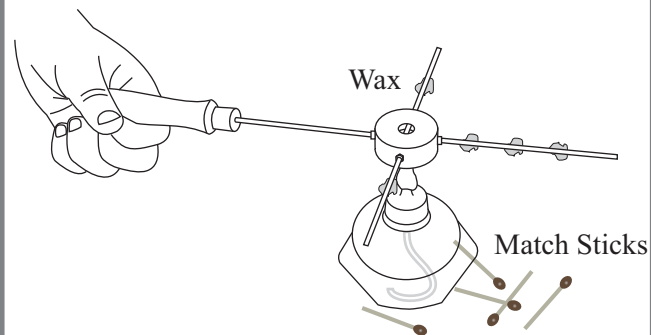

Finally the match stick fixed to the Stainless Steel rod falls.

What is going on :

When you heat all the three rods simultaneously, the match stick attached to the copper rod drops earlier. This is because the copper conducts heat faster than brass and steel. Then the match stick fixed to the brass rod drops. This is because brass conducts heat faster than steel but less faster than copper. Finally the match stick fixed to the stainless steel rod falls. In other words copper is better conductor of heat than brass and stainless steel. And Brass is best conductor of heat than stainless steel.

In the other experiment you will notice that out of the three match sticks fixed to the copper rod the match stick which is closer to the heated end drops off first. The match stick fixed at the other end (cold end) drops last. This is because the part of the rod which is in contact with the flame heats up first. Then heat is transferred along the length of the rod. When one end of the rod is heated, atoms of this end gain energy and begin

to vibrate rapidly. These atoms transfer their energy to the neighbouring atoms and they do start vibrating rapidly. this process continues until the vibrations have been transmitted to all the atoms and entire body becomes hot. Still there is a temperature gradient along the length. This method of transfer of heat is called as conduction. Metals are good conductors of heat.



Jean Baptiste Joseph Fourier

Born	March 21, 1768 Auxerre, Yonne, France
Died	May 16, 1830 Paris, France
Field	Mathematician, physicist, and historian
Known for	Fourier transform



TARANG SCIENTIFIC INSTRUMENTS



TARANG SCIENTIFIC INSTRUMENTS



HEAT CONDUCTIVITY

TARANG SCIENTIFIC INSTRUMENTS

DHARWAD

Phone : 0836-2775204

Cell : 94482 31960